

# Mounting Instruction :Smart Switch



## WARNING

Before installation, please read these Installation Instructions carefully.

1. To prevent the risk of electrocution, turn off the mains electricity supply before commencing work.
2. The device must be installed and connected by skilled electricians. otherwise it may cause short circuit or even fire.

STEP  
**1**

Remove the frame according to the proper position shown in picture.

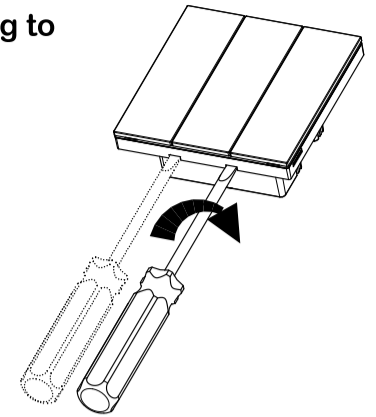

STEP  
**2**

Separate the panel from the mounting plate.

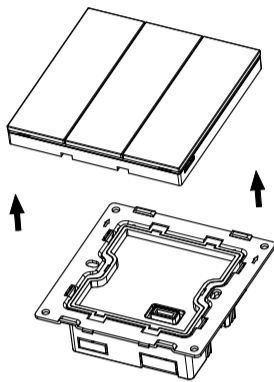

STEP  
**3**

Wiring the product. Please refer to the wiring diagram for wiring modes of various products.

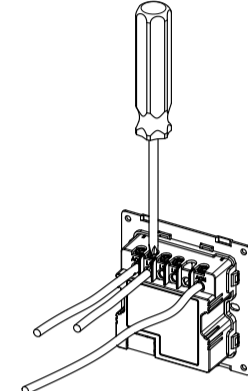

STEP  
**4**

Install the screws. Please note that the mounting torque shall not be greater than 4kg·f, otherwise the mounting plate will be deformed.

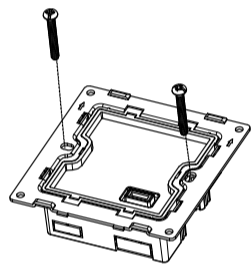

STEP  
**5**

Install the panel and finish the installation. Note that the contact pins must be aligned with the socket to avoid damaging the contact pins.

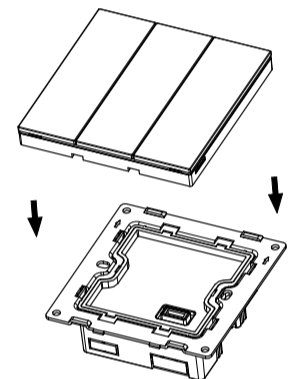

# Wiring Diagram

1 Gang Smart Switch

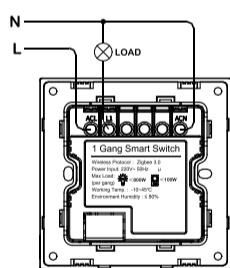

2 Gang Smart Switch

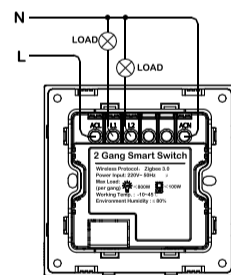

3 Gang Smart Switch

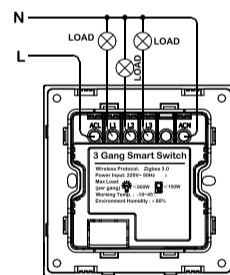

4 Gang Smart Switch

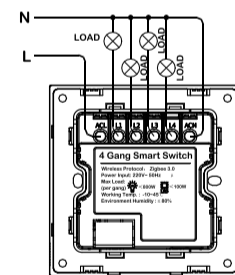

1 Gang Smart Curtain Switch

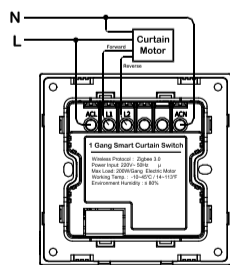

4 Gang / 6 Gang Scene Switch

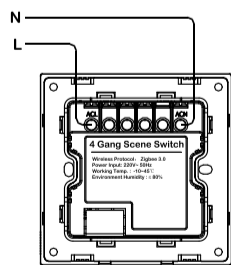

Switched 3 Pin BS Smart Socket

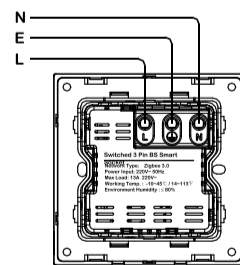

Switched 2+3 Pin Universal Smart Socket

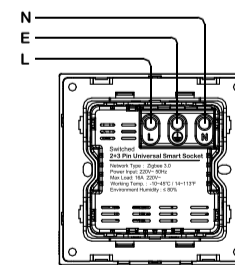

Smart Knob Dimmer Switch

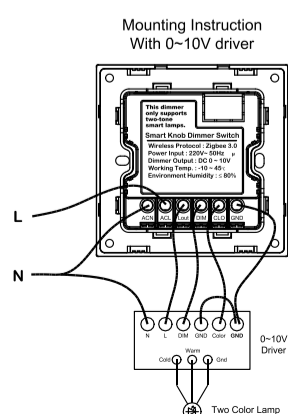

Mounting Instruction With smart driver

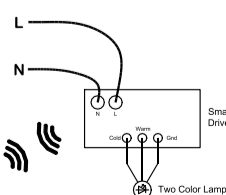
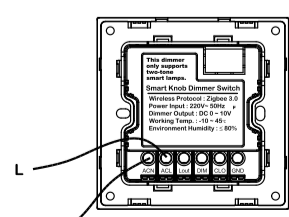

Smart Thermostat Controller

